

EXCEL™

BY JASON®

8328 MacArthur Drive
 North Little Rock, AR 72118-2199
 501.771.4477 • Fax: 501.771.2333
 Customer Service: 800.255.5766
 www.jasoninternational.com

Excel™ Series Specifications

Whirlpool & Soaking - JAK3666 SL/SR

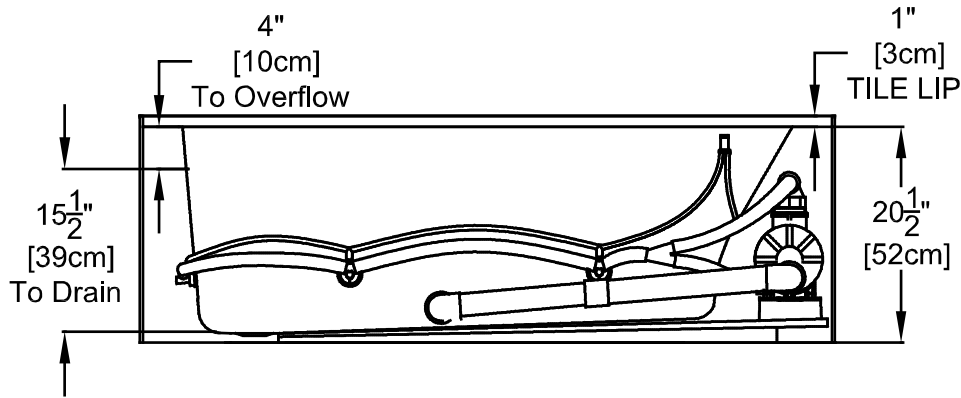
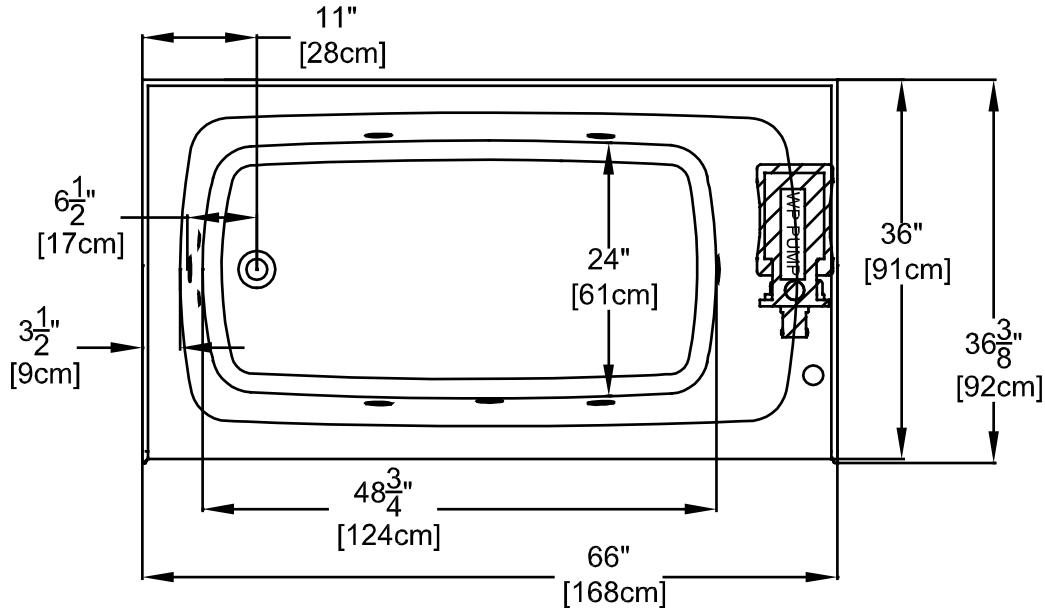

Patents received or pending.

Note: Dimensional Tolerances: ±1/4"

Drop-in-Hole Size:	N/A
Operating Capacity:	48 Gal.
Overflow Capacity:	75 Gal.
Floor Loading / sq.ft.:	51.8 lbs.
Carton Weight:	134 lbs.
Cube:	34.3 ft. ³

Air Switch Control

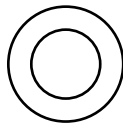

Includes a quiet, 120v, 1HP, 1-speed pump and an air switch on/off control. Requires (1) 20A, 120v GFCI protected circuit.

Construction: Reinforced Acrylic shell mounted on pre-leveled full support base.

We provide products listed with Intertek ETL SEMKO (Edison Testing Laboratories) U.S. and Canadian and with International Association of Plumbing and Mechanical Officials (IAPMO). Consult factory with your listing requirements.