

“TO BE REMOVED FOR USE BY THE OCCUPANT.”

Jason International, Inc.
8328 MacArthur Drive
North Little Rock, AR 72118
www.jasoninternational.com
MADE IN THE U.S.A.



49-1018-001
Date 06/18

OWNER'S MANUAL

Excel™ Collection Baths INSTALLATION, OPERATION, AND MAINTENANCE



If the carton shows any sign of damage, thoroughly inspect the product before accepting and describe the problem on the Bill of Lading.

Damage to the unit during installation will not be covered by warranty and is the responsibility of the installer.

ALL WARRANTY CLAIMS ON SURFACE DAMAGE MUST BE MADE PRIOR TO INSTALLATION.

Inspect plumbing and bath surface for missing or damaged components. Alert your dealer of any discrepancies.

To protect the unit from damage keep the bath in the carton until ready for installation.

EQUIPMENT ACCESS

In accordance with Building Codes, service access to all hydrotherapy bath equipment, controls and electrical connections must be provided during installation (Recommended minimum 28" x 17" [71 x 43 cm]). Insufficient access will hinder repair and maintenance. Warranty service will not cover costs of providing equipment access.

Jason offers an optional removable lateral skirt for all rectangular baths. The skirts are available in matching acrylic colors and provide convenient access to bath equipment, as well as an excellent finished appearance.

The Specification Sheet for this bath contains additional technical information. This sheet can be provided by your dealer or accessed online at www.excelbyjason.com



INSPECTION

Inspect the unit prior to installation. In the event of a problem, DO NOT install the unit.

All components are factory assembled to the system and the system is water tested and inspected prior to leaving Jason International, Inc.

NOTE: Transportation and insurance from Jason's factory are the showroom's responsibility.

Damage sustained in transit is the responsibility of the carrier. If damage is discovered, the carrier must be immediately notified in writing with a request for a representative to inspect the unit. Failure of the carrier to respond should be reported to the seller and carrier. Always file a freight claim promptly.

The installer is responsible for insuring that the unit is free from defects or shipping damage. **In the event of a problem, DO NOT install the unit.**

Jason International is not responsible for damage that might have been avoided by inspection or testing prior to installation.

OWNER'S RECORD

Dealer: _____

Date Purchased: _____

Date Installed: _____

Installer: _____

**PLACE SERIAL NUMBER CARD WITH
PRODUCT CONFIGURATION IN THIS BOX**

IMPORTANT SAFETY INSTRUCTIONS

INSTRUCTIONS PERTAINING TO THE RISK OF FIRE, ELECTRIC SHOCK, OR INJURY TO PERSONS.

This manual contains information and instructions for proper operation and maintenance of your therapy bath. Failure to follow these instructions could result in personal injury, electrical shock, or fire.

WARNING: When using this unit, basic precautions should always be followed, including the following:

READ AND FOLLOW ALL INSTRUCTIONS CAREFULLY

DANGER: TO REDUCE THE RISK OF INJURY FOLLOW THESE PRECAUTIONS:

- A. **DANGER:** To reduce the risk of injury, do not permit children to use this unit unless they are closely supervised at all times.
- B. Use this unit only for its intended use as described in this manual. Do not use attachments not recommended by the manufacturer.
- C. The water in a therapy bath should never exceed 104°F (40°C). Water temperatures between 100°F (38°C) and 104°F (40°C) are considered safe for a healthy adult. Use time should be limited to approximately 30 minutes, followed by a shower to cool down. Longer exposures may result in hyperthermia.
- D. Hyperthermia occurs when the internal temperature of the body reaches a level several degrees above the normal body temperature of 98.6°F (37°C). The symptoms of hyperthermia include an increase in the internal temperature of the body, dizziness, lethargy, drowsiness, and fainting. The effects of hyperthermia include:
 - a) Failure to perceive heat;
 - b) Failure to recognize the need to exit the hydromassage bathtub;
 - c) Unawareness of impending hazard;
 - d) Fetal damage in pregnant women;
 - e) Physical inability to exit the hydromassage bathtub; and
 - f) Unconsciousness resulting in the danger of drowning.

WARNING – The use of alcohol, drugs, or medication can greatly increase the risk of fatal hyperthermia

- E. The use of drugs or alcoholic beverages before or during therapy bath use may lead to unconsciousness with the possibility of drowning. Never use the therapy bath while under the influence of alcohol, anticoagulants, stimulants, antihistamines, vasoconstrictors, vasodilators, hypnotics, narcotics, or tranquilizers.
- F. Lower water temperatures are recommended for extended use (exceeding 10 -15 minutes) and for young children.
- G. Since excessive water temperatures have a high potential for causing fetal damage during the early months of pregnancy, pregnant or possibly pregnant women should limit therapy bath water temperatures to 100°F (38°C).
- H. Persons with a medical history of heart disease, low or high blood pressure, circulatory system problems, or diabetes should consult a physician before using a therapy bath.
- I. Persons using medication should consult a physician before using a therapy bath since some medication may induce drowsiness while other medication may affect heart rate, blood pressure, and circulation.

DANGER: To reduce the risk of injury, enter and exit the bath slowly. Do not operate this unit unless the suction cover is attached over the suction inlet fitting and the jet assemblies are installed. There should be at least two (2) inches of water above the highest jet location during therapy bath operation. **NEVER RUN UNIT DRY.**

WARNING: Never operate electrically connected devices in or near the bath. Never drop or insert any object into any opening.

This unit must be connected to a supply circuit that is protected by a GFCI. Such a device should be installed by a licensed electrician and should be tested on a regular basis (at least monthly). To test the GFCI push the **TEST** button. The GFCI should interrupt the power.

Push the **RESET** button and the power should be restored. If the GFCI fails to operate in this manner, there is the possibility of an electric shock. **DO NOT USE.** Disconnect the unit and have the problem corrected by a qualified service technician.

To avoid the possibility of personal injury and discoloration of the acrylic surface, the inlet water temperature should not exceed 40°C (104°F). The bath should be drained after each use. Each bather should start their bath with fresh water. Do not use oil base additives in your therapy bath.

CAUTION: Do not use harsh abrasives or solvents for cleaning this unit.

INSTALLER/OWNER BEARS ALL RESPONSIBILITY TO COMPLY WITH ALL STATE AND LOCAL CODES WHEN INSTALLING THIS PRODUCT

SAVE THESE INSTRUCTIONS

CONSIGNES DE SÉCURITÉ IMPORTANTES

INSTRUCTIONS RELATIVES AU RISQUE DE FEU, CHOC ÉLECTRIQUE, OU DE BLESSURE.

Ce manuel contient des informations et des instructions pour le bon fonctionnement et l'entretien de votre bain thérapeutique. Ne pas suivre ces instructions cela pourrait entraîner des blessures corporelles, un choc électrique ou un incendie.

AVERTISSEMENT: Lors de l'utilisation de cet appareil, des précautions de base doivent toujours être suivies, y compris les suivantes:

LIRE ET SUIVRE TOUTES LES INSTRUCTIONS ATTENTIVEMENT

DANGER: POUR RÉDUIRE LE RISQUE DE BLESSURES suivre ces précautions:

- A. **DANGER:** Pour réduire le risque de blessures ne permettez pas aux enfants d'utiliser cette unité à moins qu'ils ne soient étroitement surveillés en tout temps.
- B. Utiliser cet appareil uniquement pour son usage prévu, comme décrit dans ce manuel. Ne pas utiliser d'accessoires non recommandés par le fabricant.
- C. L'eau dans un bain thérapeutique ne doit jamais dépasser 40°C. Les températures de l'eau entre 38°C et 40°C sont considérées comme sans danger pour un adulte en bonne santé. Le temps d'utilisation devrait être limité à environ 30 minutes, suivi d'une douche pour se refroidir. Des expositions plus longues peuvent entraîner une hyperthermie.
- D. L'hyperthermie survient lorsque la température interne du corps atteint plusieurs degrés au-dessus de la température corporelle normale de 37°C. Les symptômes de l'hyperthermie comprennent une augmentation de la température interne du corps, des étourdissements, de la léthargie, de la somnolence et des évanouissements. Les effets de l'hyperthermie comprennent:
 - a) incapacité à percevoir la chaleur;
 - b) Défaut de reconnaître la nécessité de sortir de la baignoire d'hydromassage;
 - c) L'ignorance des dangers imminents;
 - d) Dommages fœtaux chez les femmes enceintes;
 - e) incapacité physique de sortir de la baignoire d'hydromassage; et
 - f) Inconscience entraînant le danger de noyade.
- E. Des températures d'eau plus basses sont recommandées pour une utilisation prolongée (plus de 10-15 minutes) et pour les jeunes enfants.
- F. Puisque les températures excessives ont un potentiel élevé pour les fœtus durant les premiers mois de la grossesse, les femmes enceintes ou possiblement enceintes doivent limiter la température de l'eau de bain de traitement à 38°C.
- G. Personnes ayant des antécédents de maladie cardiaque, d'hypotension ou d'hypertension artérielle, de troubles circulatoires ou de diabète doivent consulter un médecin avant d'utiliser un bain de thérapie.
- H. Les personnes utilisant des médicaments devraient consulter un médecin avant d'utiliser un bain de thérapie puisque certains médicaments peuvent induire la somnolence tandis que d'autres peuvent affecter le rythme cardiaque, la pression artérielle et la circulation.

DANGER: Pour réduire le risque de blessures, entrer et sortir du bain lentement. Ne pas utiliser cet appareil si le couvercle d'aspiration est monté sur l'entrée de raccord d'aspiration et les ensembles de jet sont installés. Il devrait y avoir au moins deux (2) pouces d'eau au-dessus de l'emplacement du jet le plus haut pendant le fonctionnement du bain de traitement. **JAMAIS RUN appareil au sec.**

AVERTISSEMENT: Ne jamais faire fonctionner les appareils connectés électriquement à ou près de la baignoire. Ne jamais laisser tomber ou insérer un objet dans une ouverture.

Cet appareil doit être relié à un circuit d'alimentation qui est protégé par un disjoncteur différentiel. Un tel dispositif doit être installé par un électricien agréé et doit être testé sur une base régulière (au moins mensuellement). Pour tester le GFCI appuyez sur le bouton **TEST**. Le GFCI doit interrompre l'alimentation. Appuyez sur le bouton **RESET** et le courant devrait être rétabli. Si le disjoncteur ne fonctionne pas de cette manière, il ya la possibilité d'un choc électrique. **NE PAS UTILISER.** Débranchez l'appareil et faire corriger le problème par un technicien qualifié.

Pour éviter le risque de blessures et de la décoloration de la surface acrylique, la température de l'eau d'entrée ne doit pas dépasser 40°C (104°F). Le bain doit être vidé après chaque utilisation. Chaque baigneur doit commencer leur bain à l'eau fraîche. Ne pas utiliser d'additifs à base d'huile dans votre bain de thérapie.

Tous les codes d'état et locaux doivent être respectés lors de l'installation de cette unité.

CONSERVER CES INSTRUCTIONS

Cautionary Warnings (English/French)

CAUTION: Ambient temperature under the bath where equipment is installed must not exceed 122°F (50°C).

WARNING: Any modification to the equipment is not recommended and will void the Manufacturer's warranty.

DANGER - RISK OF ELECTRIC SHOCK: Connect only to a circuit protected by a Ground Fault Circuit Interrupter (GFCI). In the unlikely occurrence of a current imbalance in the power conductors, the GFCI will interrupt the power to the bath.

WARNING: The electrical service to the GFCI must not be interrupted by any control device. Likewise, the electrical service from the GFCI to the bath control should be direct and not interrupted by a switch. Never use a switch in conjunction with a control device.

This will VOID THE MANUFACTURER'S WARRANTY.

DANGER - Do not alter the factory installed wiring. All building materials and wiring should be routed away from the equipment or other heat-producing components of the unit.

CAUTION: Keep hair, towels, and clothing away from the suction fitting whenever the equipment is On. Never operate the equipment with the suction cover off, doing so voids the manufacturer's warranty--it is a safety cover designed to eliminate the potential of hair and body entrapment.

WARNING: Before operating refer to the instructions at the end of this owner's manual pertaining to the risk of fire, electric shock, or injury to persons.

WARNING: Avoid high humidity levels in your home. Mold, mildew, fungi and bacteria which may be harmful to health thrive in areas with continued high humidity levels; therefore, every precaution should be taken to make sure your plumbing fixtures including bathtubs, therapy baths, or showers do not become a source of high humidity due to improper installations or leaks.

WARNING: Always turn off power at the main electrical service panel when servicing the bath

CAUTION: Risk of Electric Shock - Two disconnect switches are required to de-energize the unit before servicing. [For baths requiring two circuits]

CAUTION: Not Suitable for Field-Installed Heater

ATTENTION: la température ambiante sous la baignoire où l'équipement est installé ne doit pas dépasser 50°C.

AVERTISSEMENT : Toute modification de l'équipement n'est pas recommandée et annulera la garantie du fabricant.

DANGER - RISQUE DE CHOC ÉLECTRIQUE : Connecter uniquement à un circuit protégé par un disjoncteur (GFCI). Dans l'éventualité peu probable d'un déséquilibre de courant, le GFCI coupera le courant du bain.

AVERTISSEMENT : Le service électrique au GFCI ne doit pas être interrompu par un dispositif de contrôle. De même, le service électrique du GFCI au contrôle de bain doit être direct et ininterrompu par un contrôleur. Ne jamais utiliser un commutateur en conjonction avec un dispositif de commande.

Cela annulera la garantie du fabricant.

DANGER - Ne pas modifier le câblage installé en usine. Tous les matériaux de construction et câblage doivent être éloignés de toutes sources de chaleur modérées par le bain.

ATTENTION : Garder les cheveux, les serviettes et les vêtements à distance du raccord d'aspiration lorsque l'appareil est allumé. Ne jamais faire fonctionner l'équipement avec l'aspiration couvrant off, cela annule la garantie - c'est un dispositif de sécurité conçu à éviter l'occlusion du corps et des cheveux.

AVERTISSEMENT: Avant d'opérer le bain consulter les instructions à la fin de ce manuel concernant les risques d'incendie, de choc électrique ou de blessure ce propriétaire.

AVERTISSEMENT: Évitez les hauts niveaux d'humidité dans votre maison. Les Moisissures, champignons et certaines bactéries peuvent être nocifs pour la santé et se développer dans ces zones; par conséquent, toutes les précautions doivent être prises pour vous assurer que votre plomberie, y compris les baignoires, bains thérapeutiques, ou les douches ne deviennent pas une source de forte humidité due à une mauvaise installation ou de fuites.

AVERTISSEMENT: Toujours couper l'alimentation électrique au panneau de service électrique avant la maintenance.

ATTENTION : Risque de choc électrique - Deux interrupteurs de déconnexion sont nécessaires pour mettre l'unité hors tension avant l'entretien. [Pour les bains nécessitant deux circuits]

ATTENTION: Ne convient pas aux appareils de chauffage installés sur le terrain

FEATURES, CONTROLS AND OPERATING INSTRUCTIONS

INTRODUCTION

This manual contains all of the information needed for the proper installation and operation for your Excel™ bath. The bath has been designed to give you years of relaxing trouble-free service, provided the unit is maintained and operated in accordance with these instructions.

Thoroughly clean and disinfect the unit as described in the **CLEANING** section of the **USER MAINTENANCE INSTRUCTIONS** section of this owner's manual before its first use and periodically thereafter.

CAUTION: Keep hair, towels and clothing away from any installed suction fitting whenever the equipment is ON. Never operate the equipment with the suction cover off, doing so voids the manufacturer's warranty—it is a safety cover designed to eliminate the potential of hair and body entrapment.

All Jason Excel™ baths are pre-plumbed at the factory.

WARNING: Before operating, refer to the instructions at the beginning of this owner's manual pertaining to the risk of fire, electric shock or injury to persons.

Filling and Draining

Close the drain and fill the bath with water to the desired level (at least two (2) inches (50mm) above the jet). The inlet temperature should not exceed 104°F (40°C). When bath is in use, turn the unit OFF before draining the water. The bath unit and its plumbing are designed to drain after each use whether used as a hydrotherapy bath, soaking bath, or just taking a shower.

NOTE: If the unit fails to operate, check the breaker panel to ensure that the circuit breaker is on. Check the GFCI by testing and resetting it. If the unit still fails to operate, refer to the Trouble Shooting Guide section of this manual. If the unit still fails to operate and is out of warranty, contact an authorized service technician for repair. If the unit is within the warranty period, contact JASON Technical Services at 800-255-5766. **DO NOT ATTEMPT TO RESOLVE THE PROBLEM.**

WHIRLPOOL FEATURES

Whirlpool Pump

Whirlpool pumps provided on Jason baths are factory tested after installation on the bath. The pumps are of efficient design incorporating high quality long life seals which provide superior service. However, should the pump need service; suction and discharge unions are provided for easy pump removal.

Whirlpool Jets

Strategically placed whirlpool jets are provided for complete enjoyment of your bath. The jets are specially designed for maximum whirlpool action with directional capabilities. By changing the direction of the jets, you can concentrate the massaging jet stream to your area of preference. You can also individually adjust the flow of each jet.

Pneumatic ON/OFF Button

The Pneumatic On/Off button (air switch activator) provides a safe and convenient method for controlling the Whirlpool bath. The Pneumatic On/Off button is factory mounted onto the bath prior to shipment. To operate, fill the bath to at least two (2) inches above the jets and press the Pneumatic On/Off button to start or stop the whirlpool pump.

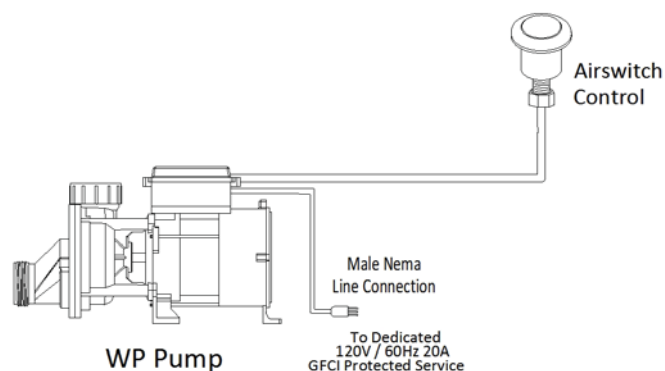

FEATURES, CONTROLS AND OPERATING INSTRUCTIONS (cont.)

AIR FEATURES

AirMasseur® Blower

The blower generates warm air and pushes it through the strategically placed air jets. The AirMasseur system contains a variable speed-controlled heated air blower. Blowers provided on Jason baths are factory tested when assembled on the bath.

Pneumatic ON/OFF Button

The Pneumatic On/Off button (air switch activator) allows the user to turn the blower On and Off and controls the blower's intensity. Momentarily depress the button to start or stop the air blower. A timer will automatically stop the air blower after 20 minutes of operation if it is not stopped manually.



Blower Speed

Once the blower is On, to decrease the air output, press and hold the Air On/Off button until the desired intensity is reached, then release the button. To increase the air intensity, press and hold the Air On/Off button until the desired intensity is reached, then release the button.

AirMasseur® Automatic Purge

Fifteen (15) minutes after the blower is stopped, the blower will start again for a two (2) minute purge cycle that dries the air channel.

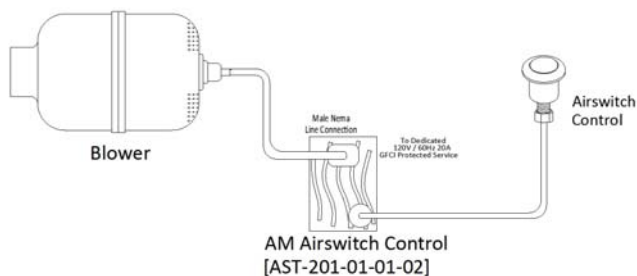

REMOTE MOUNTING OF AIR BLOWER

The Jason AirMasseur® system has been factory installed following ETL/UL Standard safety guidelines. During installation, if remote mounting of the air blower is desired or required, the following procedures should be followed.

Note: Do not remote mount the blower more than 15 feet [4.5m] away from the air inlet of the bath. Choose a location as close as possible to the bath to ensure maximum efficiency.

1. The installer must determine the layout of the piping; exact remote mount location; and service access before beginning any work. Use 1.5" ABS or PVC plastic tubing. Locate the blower in an area accessible for servicing.
2. **Note:** A 15 foot extension cable set can be purchased from your Jason supplier, if needed. To ensure proper functioning of the system, avoid remote mounting in a location which requires more than six (6) piping direction changes. A 90° direction change should be made up of two 45° elbows for maximum efficiency.
3. If the blower has been factory installed, disconnect the blower from the air bath plumbing by removing the two (2) screws on the check valve outlet and disconnect the short piece of pipe between the check valve and the elbow by removing the two (2) screws in the elbow. [Omit this step on baths where the blower is not factory installed and remote mounting is required.]
4. Install the blower in the remote location. The remote mount location ambient air temperature should remain at approximately 72°F [22°C] for optimum air heating.
5. Make sure the blower is well ventilated. The blower mount should be attached firmly to the floor. Piping between the remote blower location and the bath can be insulated using a minimum of ½" [13mm] thick insulation. Attach new piping to the elbow of the existing piping.

USER MAINTENANCE INSTRUCTIONS

HUMIDITY

WARNING: Avoid high humidity levels in your home. Mold, mildew, fungi and bacteria which may be harmful to health thrive in areas with continued high humidity levels; therefore, every precaution should be taken to make sure your plumbing fixtures, including bathtubs, hydrotherapy baths or showers do not become a source of high humidity due to improper installations or leaks.

To avoid having your plumbing fixtures become a source of unwanted humidity, please make sure the following steps are taken prior to installation.

1. Make sure the area where the bathtub or shower is installed is well vented and allows enough ventilation and air circulation to dry the bathroom environment within a short time after taking a bath or shower.
2. If your bath or shower unit is tiled-in, use units with an integral tile flange or make sure a tile flange kit or similar mechanical barriers is installed to prevent shower spray, splash or overflow to leak behind the bathtub.
3. Make sure the plumber properly tests your hydrotherapy bath before it is roughed in to make sure there are no leaks and it is installed with proper access to bath equipment.
4. Make sure that all the plumbing and fixtures in the bathroom are in good working order and have no leaks.
5. Do not use carpeting or other material or furniture which can hold moisture in your bathroom.
6. Use disinfectant to clean any bathroom surfaces which are regularly exposed to moisture.
7. Clean and disinfect humidifier and dehumidifiers as recommended by the manufacturer. Replace the air filter on the HVAC unit once a month.
8. Clean moldy surfaces as soon as any mold appears by using a detergent/soapy solution and appropriate household cleaner. Always use gloves during cleaning. Dispose of any sponges or rags used to clean mold.

CLEANING

With minimum care, your acrylic-surfaced bath will retain its high-luster finish for many years. For regular cleaning use Jason Bath Cleaner or a mild NON-ABRASIVE liquid detergent solution (i.e. glass cleaner) and a soft, wet cloth or sponge. Do not run the hydrotherapy system with foaming cleaners or soaps. Rinse the bath thoroughly after cleaning.

SURFACE MAINTENANCE

Area with minor scratches or dull surfaces can be restored by applying commercially available plastic polish (i.e. Novus Plastic Polish No. 2, available at your Jason dealer), followed by an application of acrylic paste wax. Buff the surface with a clean soft cloth. Do not use sandpaper, steel wool or abrasive rubbing compounds.

If scratches are too deep to rub out, or if the damage penetrates the acrylic surface, consult your dealer for recommendations on surface repair.

AIR HEATER AND AIR TEMPERATURE

The air heater incorporated into the air blower is designed to preheat the incoming air to body temperature, not to heat the bath water. The air heater automatically comes on when the air blower is activated. Even though all air baths provide preheated air, occasionally some people with sensitive skin might experience a cold air sensation. This sensation is caused by the swiftly moving heated air bubbles blowing on the wet skin. This phenomenon can be related to the use of a fan for cooling on a hot day. While the ambient temperature does not change, the moving air makes you feel cooler. Avoiding this cold air sensation is among the reasons Jason avoids placing air jets directly beneath the body. If you experience a cool air sensation, which is most noticeable during the first few minutes of an air bath, simply move your body slightly away from the closest jets.

FLUSHING / SANITIZING

Upon start-up and not to exceed 90 days, your bath and plumbing system should be flushed. To do so, close the drain and fill the bath with warm water to at least two (2) inches [5.1cm] above the highest jet. Pour in Jason Bath System Cleaner and follow the directions on the bottle. DO NOT use bleach or other chlorinated cleansers directly on the metal trim.

REPAIR

Refer all plumbing or electrical repair to a qualified service technician. DO NOT ATTEMPT TO RESOLVE THE PROBLEM. This can result in danger of electrical shock or damage to the unit and will VOID THE WARRANTY. Remember, when contacting your dealer or service representative; always have your serial number, proof of purchase and model number. This will ensure a quick response on warranty items. The serial number can be found on the front page of this manual or on the small card adhered to the underside of the bath just above the equipment.

ALL WARRANTY REPAIRS MUST BE AUTHORIZED BY THE MANUFACTURER BEFORE WORK IS STARTED.

INSTALLATION INSTRUCTIONS

INSTALLATION

1. Finish Frame

A finish frame under the shell rim should always be constructed to support the bath deck and ensure proper drainage toward the bath well. This frame is not intended to support the full bath weight. See **Figures 1 and 2**. Allow ample clearance for any equipment that may be installed on the bath.

CAUTION: Ambient temperature under the bath where equipment is installed must not exceed 122°F (50°C).

Drop In Framing

The drop in opening should be approximately one (1) inch [2.5cm] less than the outer dimensions of the bath. Full size templates are included with the bath packaging for oval tubs.

Figure 1

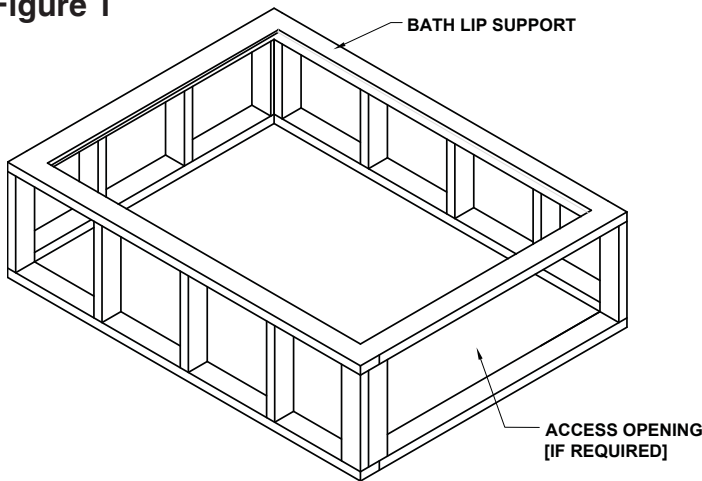

Alcove Framing

For 3-wall alcove installations, install a 1"x2" ledger strip to support the tile lip flange. See the **Integral Tile Lip Alcove Installation** section for further instructions.

Figure 2

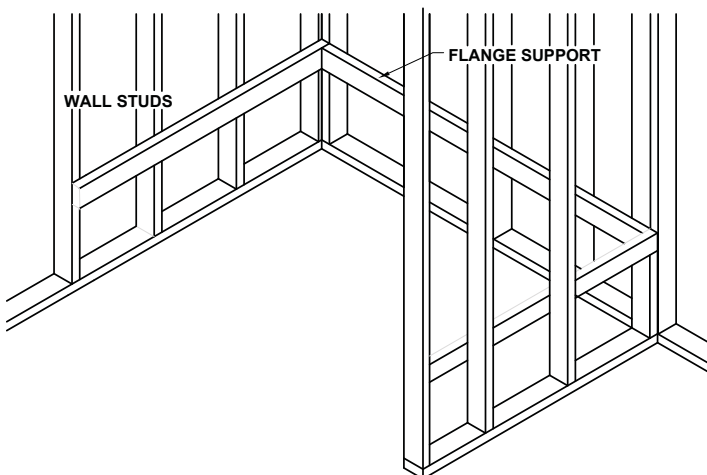

2. AirMasseur® Ventilation (AM baths)

A minimum ventilation opening of 2" x 4" [5x10cm] for the AirMasseur blower is required. It should be designed to draw in indoor ambient air at a minimum of 72°F [22°C].

3. Drain and Overflow

Install the drain and overflow assembly to the bath shell according to the instructions provided with the drain and position the bath in the area of intended installation. Finish plumbing rough-in of drain and overflow assembly. At this time, considerations should be made for the position and mounting of the faucet set, as well as all related plumbing.

4. Level Installation

To ensure proper operation, the bath must be leveled by the rim of the tub. The full length of the bath bottom should be supported by a mortar bed or other bedding compound. Spread a 2" [5cm] thick layer of mortar on the subfloor where the bath will be installed to help secure, level and support the bath. A plastic sheet barrier can be placed on top and underneath the mortar bed.

Set the bath in the mortar bed. Shift the bath from side to side to settle into the mortar bed. The tub will not drain properly if the bath is not level both front to back and side to side. Caution should be taken to prevent damage to any plumbing or other options when installing the bath. Let the mortar harden overnight before use.

Failure to properly bed and install the bath will void any warranty on the tub shell.

Note: Do not use a sand bed to install or level the bath.

Figure 3

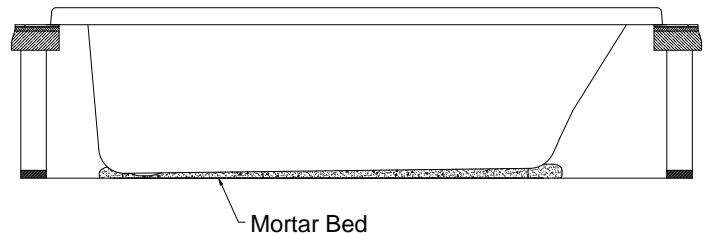

INSTALLATION INSTRUCTIONS (cont.)

5. Integral Tile Lip Alcove Installation

After the bath has been leveled, confirm the height measurement of the underside of the flange deck in order to install a 1"x2" ledger strip to support the tile lip flange (see Figure 4).

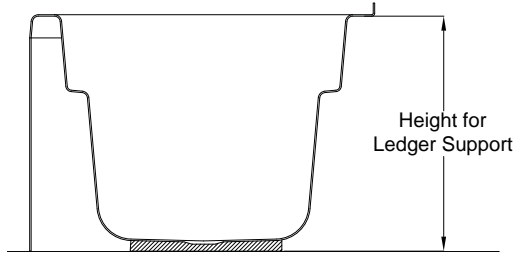

Figure 4

Install the 1" x 2" support ledger strip to the framing to allow support along the entire rear ledge of the bath (see Figures 2 and 5).

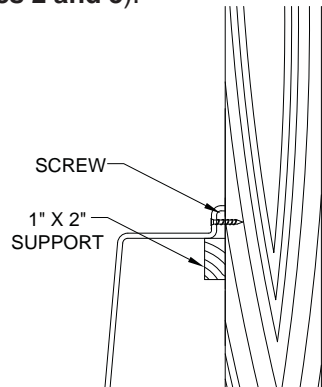

Figure 5

Carefully drill 1/8" holes through the tile flange at each stud location.

NOTE: Be sure not to drill the hole at an angle as this can cause negative draft on the flange and result in water pooling on the deck.

Secure the flange to the stud with screws making sure the screws are installed parallel to the bath to avoid negative draft.

WARNING: To prevent damaging the acrylic, be careful not to over-tighten the screws.

6. Tile Flange

100% Silicone with mildew resistant properties should be applied between the water resistant backer board and the deck of the deck.

Note: If you use a tile flange kit, modify the framing to support the bath lip as shown in Figure 6.

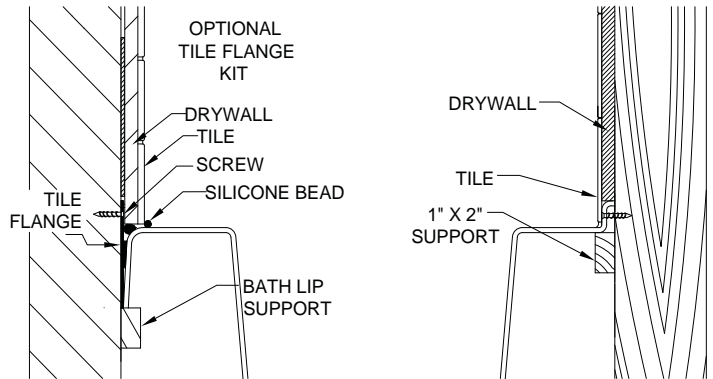

Figure 6

7. Acrylic Bath Surface

The acrylic surface of this bath has been provided with a protective film which helps protect the bath during shipment and installation. If the bath is tiled in, remove the necessary portion of the film when installing the tile.

Additional protection may also be required to protect the acrylic surface during installation. Protect the acrylic bath surface from damage during installation with a suitable material, i.e. cardboard and/or plastic film.

8. Cleaning

Remove all loose debris. Construction plaster or excess grout can be removed with the use of a wood (edge) trowel. Paint or tar stains may need to be removed with a cleaner such as paint thinner, turpentine or rubbing alcohol. Never allow the cleaner to soak against the acrylic surface for long periods of time. **Always rinse the surface immediately following the use of cleaners.**

9. Water Testing

Before finishing the installation, it is recommended that the bath be water tested and any plumbing tested for leaks.

INSTALLATION INSTRUCTIONS (cont.)

ELECTRICAL INSTALLATION

These instructions are written assuming 60Hz, 120V power supply. Verify the electrical requirements of the bath unit before installation. Refer to the equipment labels for voltage and frequency requirements.

Note: This bath is designed for indoor use only. The electrical equipment must not be exposed to direct or indirect water or moisture contact. The electrical equipment must also be protected from dust and other airborne debris before, during and after installation.

A licensed electrician must provide the “dedicated” electrical service protected by a GFCI. The location of the GFCI must be at least five (5) feet [152cm] away from the inside surface of the bath, accessible for regular testing. Use copper conductors only.

DANGER - RISK OF ELECTRIC SHOCK: Connect only to a circuit protected by a Ground Fault Circuit Interrupter (GFCI). In the unlikely occurrence of a current imbalance in the power conductors, the GFCI will interrupt the power to the bath.

WARNING: The electrical service to the GFCI must not be interrupted by any control device. Likewise, the electrical service from the GFCI to the bath control should be direct and not interrupted by a switch. Never use a switch in conjunction with a control device. This will VOID THE MANUFACTURER’S WARRANTY.

The pumps are supplied with an electrical bonding lug to allow connection of a solid copper bonding conductor between the unit and other electrical equipment and exposed metal in the area as may be required by local code. **Note:** The air blower’s exterior housing is made of all plastic materials and does not require a bonding conductor.

Grounding is required. The unit should be installed by a qualified service representative and properly grounded.

Install the service connection at least six (6) inches [15cm] above the sub floor.

All local and state electrical and plumbing codes must be observed. Where there are no local codes, the National Electric Code (NEC) and Uniform Plumbing Code (UPC) shall be observed. It is the responsibility of the installer/owner to determine specific code compliance prior to installation of the product.

Note: In the Commonwealth of Massachusetts, installation is to be done by a Massachusetts licensed plumber.

DANGER - Do not alter the factory installed wiring. All building materials and wiring should be routed away from the equipment or other heat-producing components of the unit.

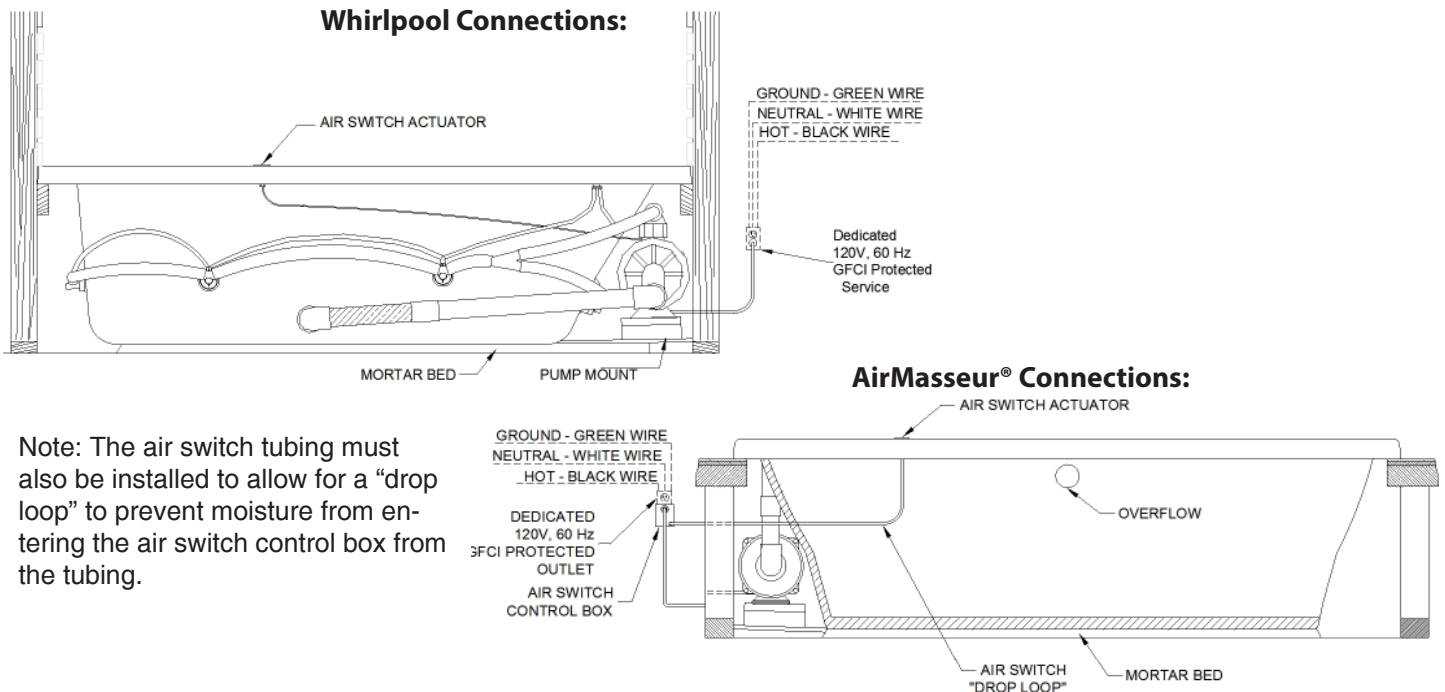

Note: The air switch tubing must also be installed to allow for a “drop loop” to prevent moisture from entering the air switch control box from the tubing.

TROUBLE SHOOTING GUIDE

If you believe the unit to be within the warranty period, you must contact Jason Customer Service: 1-800-255-5766 with the bath's Product and Serial numbers before work is started. These numbers can be found on the label on the front page of this manual and also adhered to the underside of the bath above the equipment.

ALL WARRANTY REPAIRS MUST BE AUTHORIZED BY JASON BEFORE WORK IS STARTED.

FOR SERVICE, ALWAYS CONTACT YOUR DEALER OR AUTHORIZED SERVICE CENTER.

WARNING: Always turn off power at the main electrical service panel when servicing the bath

ALL SYSTEMS		
SYMPTOMS	POSSIBLE CAUSES	RECOMMENDED ACTION
System fails to operate	<ul style="list-style-type: none"> a. No power to the motor or control box b. Motor is not plugged into control box c. Pneumatic switch/Plastic air tubing disconnected or broken 	<ul style="list-style-type: none"> a. Reset circuit breakers and GFCI if tripped. Check fuses and replace if bad. Check voltage at motor when control is on. If no voltage, control is defective. b. Make sure plug is fully inserted into the control box outlet. c. Check and reconnect if necessary.
Equipment does not manually shut off.	<ul style="list-style-type: none"> a. Control defective 	<ul style="list-style-type: none"> a. Refer to installer/dealer.
Equipment shuts off by itself or before set time elapses.	<ul style="list-style-type: none"> a. Motor overheated and thermal protection device deactivated motor. (Possible low voltage) b. GFCI tripped. 	<ul style="list-style-type: none"> a. Make sure motor has sufficient ventilation, clear any obstructions and allow motor to cool down. Check service and wire size. b. Refer to Jason Customer Service
Circuit breaker trips repeatedly	<ul style="list-style-type: none"> a. Defective breaker b. Short circuit between the bath and the breaker box. c. Other items are connected to the same circuit. 	<ul style="list-style-type: none"> a. Replace breaker b. Refer to installer/dealer. c. Refer to installer/dealer.

AIRMASSEUR® [AM] BLOWER SYSTEM		
SYMPTOMS	POSSIBLE CAUSES	RECOMMENDED ACTION
Blower turns on when not in use.	<ul style="list-style-type: none"> a. Purge cycle has started. 	<ul style="list-style-type: none"> a. No action is needed. This is a normal feature to help keep the air channel dry and sanitary.

TROUBLE SHOOTING GUIDE

WHIRLPOOL [WP] PUMP SYSTEM		
SYMPTOMS	POSSIBLE CAUSES	RECOMMENDED ACTION
Pump operates, but no air is injected into the water.	a. Air intake clogged.	a. Refer to installer/dealer.
Pump operates, but water is not being pumped.	a. Suction or discharge blocked. b. Suction air leak. (System usually surges)	a. Check and remove obstruction b. Make sure union is tight on suction side of the pump.
Pump leaks.	a. Damaged or defective seal b. Unions cracked, under-tightened, over-tightened or O-Ring is not seated properly (possibly pinched).	a. Refer to installer/dealer b. Refer to installer/dealer.
Whirlpool jet not working.	a. Jason jets can be individually opened or closed.	a. Ensure the jet is in the open position.

WARRANTY REGISTRATION: Register your product's warranty online at www.jasoninternational.com.

JASON INTERNATIONAL INC. LIMITED WARRANTY

The Company warrants the products of its own manufacture to be free from defects in workmanship and material for a period of twelve (12) months from date of installation or eighteen (18) months from date of manufacture, whichever comes first. Any merchandise which upon Company examination proves to be defective under normal use and service during the warranty period will be at the Company's option repaired, replaced or credit issued in the amount of the invoice value of the defective merchandise. All other types of remedies are excluded. This warranty extends only to the owner of the originally installed merchandise. The Company is not responsible for labor or other installation costs for the repair or replacement of defective merchandise. Company reserves the right to substitute new or improved equipment on any replacements. The repair or replacement of equipment shall be F.O.B. point of shipment.

This warranty shall not apply to any merchandise which has been subject to accident, alteration, abuse, misuse, abrasives, corrosion and/or electrolysis, improper voltage supply, misapplication, careless handling, improper installation, maintenance, abnormal chemical conditions, nor does this warranty cover stains, discoloration or the fading of color due to improper use of chemicals or improperly maintained water chemistry.

This warranty shall not apply to any merchandise or parts thereof which were not manufactured by Company. Such product or merchandise manufactured by others shall have only such warranties, in writing, that may be extended and in force at the time by such other manufacturer or supplier.

To obtain warranty service, you must contact the retailer from which the merchandise was purchased or Company's distributor in your area. Written notice of warranty defects must be given to the company within thirty (30) days from the occurrence thereof. Written permission must be obtained by the retailer or distributor from the Company before any equipment claimed defective is returned for inspection.

EXCEPT AS PROVIDED HEREIN, COMPANY MAKES NO WARRANTIES EITHER EXPRESSED OR IMPLIED, AS TO ANY MATTER WHATSOEVER INCLUDING THE CONDITION OF THE MERCHANDISE, ITS MERCHANTABILITY OR FITNESS FOR A PARTICULAR PURPOSE. ANY WARRANTIES IMPLIED BY LAW AND NOT EFFECTIVELY EXCLUDED BY THIS WARRANTY, ARE LIMITED TO THE DURATION AND REMEDIES OF THIS WARRANTY. IN NO EVENT SHALL THE COMPANY BE LIABLE FOR CONSEQUENTIAL OR INCIDENTAL DAMAGES.

Some states do not allow limitations on how long an implied warranty lasts or the exclusion or limitation of incidental or consequential damages, so the above limitations may not apply to you.

This warranty gives you specific legal rights and you may also have other rights that vary from state to state.

SAVE THESE INSTRUCTIONS

JASON INTERNATIONAL, INC.
 8328 MacArthur Drive • North Little Rock • Arkansas • 72118-2029
www.jasoninternational.com